

PRODUCT CARD			
PRODUCT MODEL	MSBP0125A01HV1-TM1		
PRODUCT WEIGHT (Kg)			
DESCRIPTION	125A 01 UPS NONE ANALYZER INPUT-OUTPUT=3 POLE BY PASS=4 POLE		
FEATURES			
KEY TYPE	THERMAL MAGNETIC CIRCUIT BREAKER	UPS QUANTITY	1
POWER ANALYZER	NO	POWER LAMP.	YES
BRAND	CHINT		

SINGLE LINE DRAWINGS

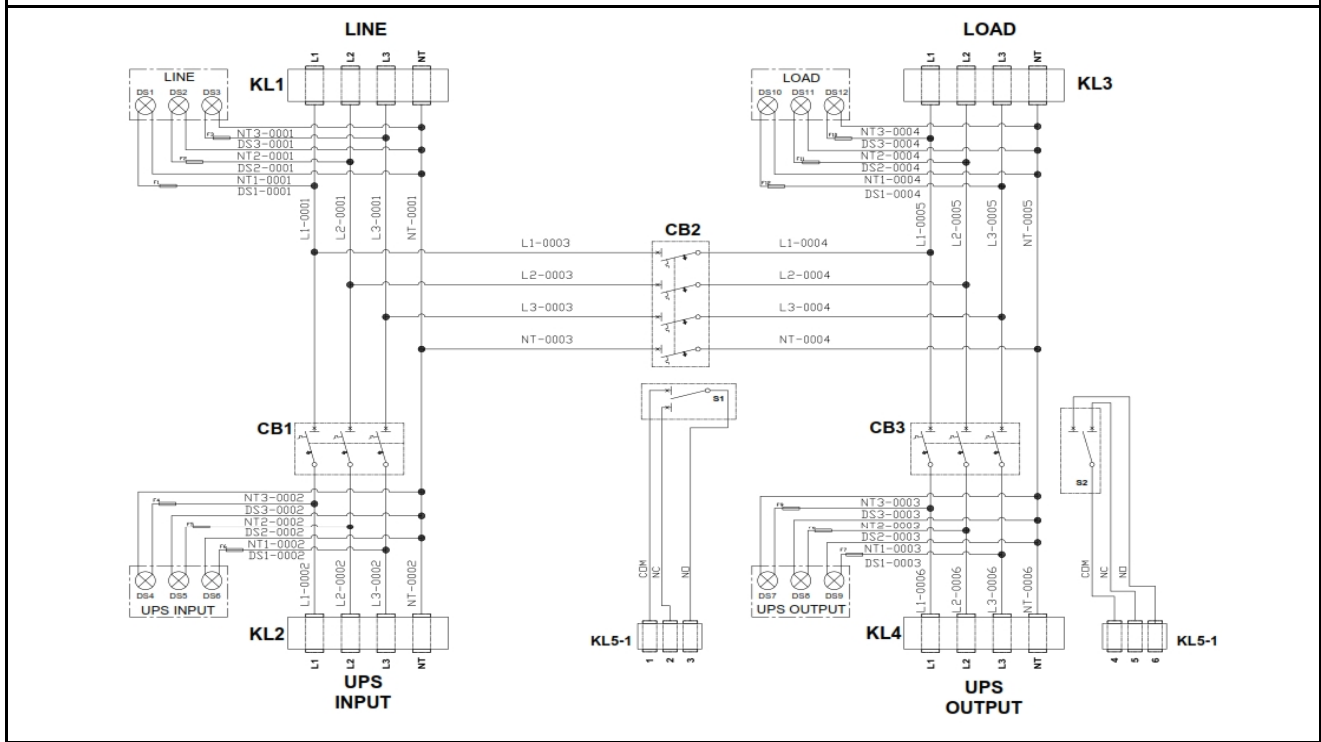

PANEL

PANEL CODE	MKSBP0012	PANEL WEIGHT(Kg)	
SIZE(mm)(WxHxD)	500 x 600 x 200	ASSEMBLY SIZE(mm)(WxHxD)	568 x 628,5 x 223
USED RECORDS	PG 21	1 PIECE	PG 29
			4 PIECE

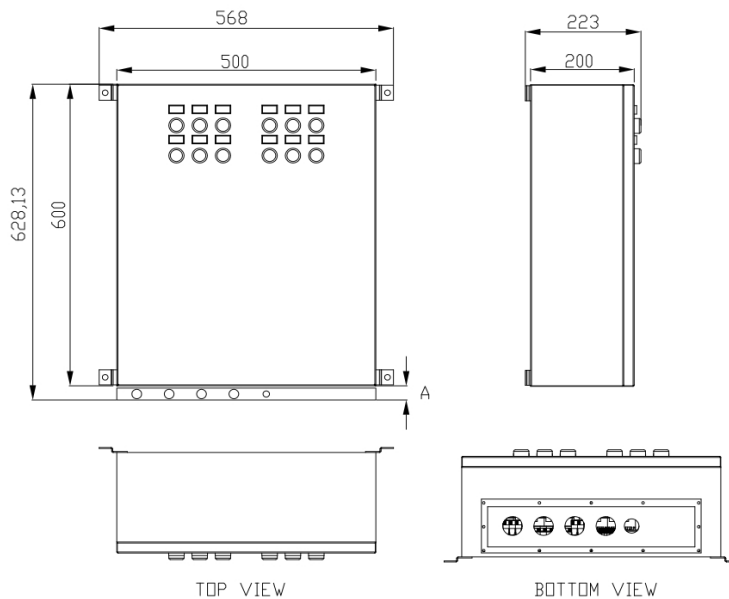

TYPES OF RECORD

NAME	A	∅
PG 21	43 mm	28 mm
PG 29	40 mm	27 mm